

1P CIRCULAR ASSEMBLY P/N DESCRIPTION :

1P X M1 X X XX X X B X X  
 ① ② ③ ④ ⑤ ⑥ ⑦ ⑧

- ① Type  
 A=Shell:PSU Grey  
 B=Shell:PSU Black  
 C=Shell:PEI Grey  
 D=Shell:PEI Black  
 E=Shell:PPSU Grey  
 F=Shell:PPSU Black  
 1=Shell:ABS Grey  
 2=Shell:ABS Black
- ② Insert  
 P=PEEK  
 S=PPS
- ③ Plating  
 2=High Gold  
 A=Gold flash
- ④ Number of contacts  
 02=2Pin  
 .....  
 14=14Pin
- ⑤ Keying  
 G= 0° (2-14Pin)      H= 170° (8,10&14Pin)  
 A= 40° (2-14Pin)      J= 205° (8,10&14Pin)  
 B= 60° (2-14Pin)  
 C= 80° (2-14Pin)
- ⑥ Cable collet  
 3=φ3.9mm (Cableφ=2.7~3.9mm)  
 5=φ5.2mm (Cableφ=4.0~5.2mm)  
 6=φ6.5mm (Cableφ=5.3~6.5mm)
- ⑦ Nut Colour  
 8=Grey (Keep in line with shell)  
 0=Black (Keep in line with shell)
- ⑧ Logo  
 0= No Logo      A= No Logo&With Ink mark  
 1= With Logo    B=With Logo&With Ink mark

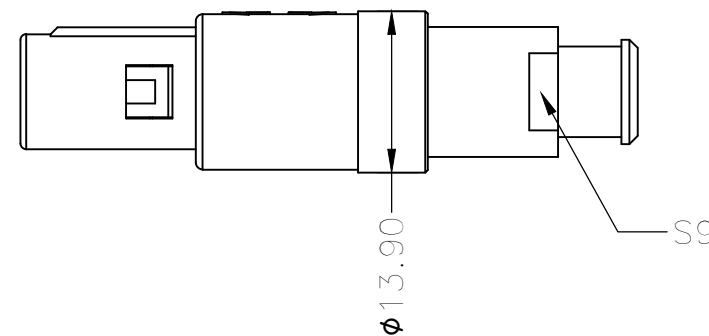
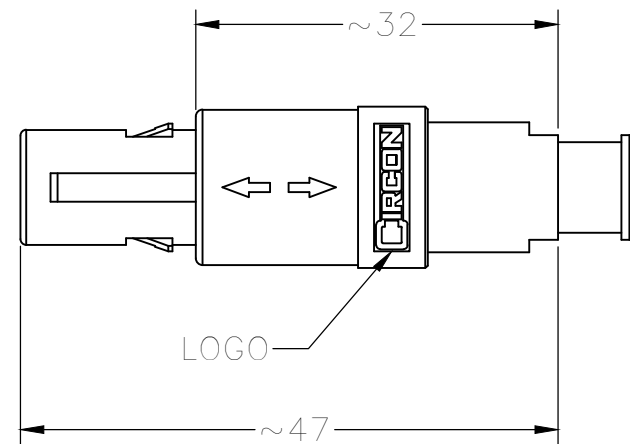
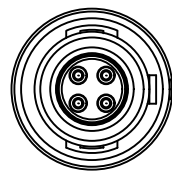
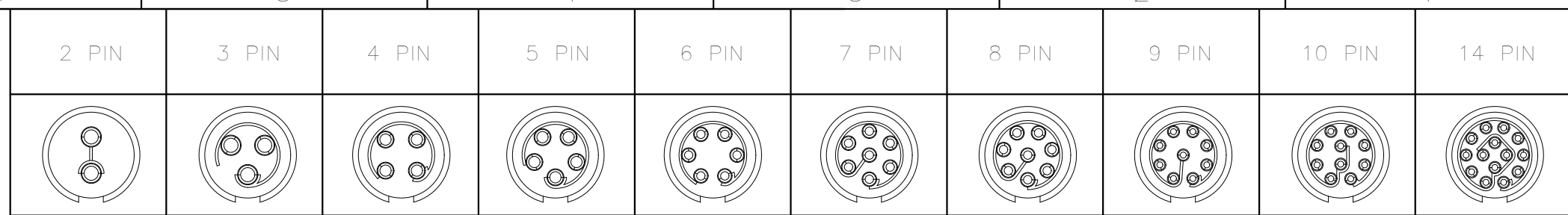

NOTE:

- 1. MATERIAL:
  - 1.1.SHELL: THERMOPLASTIC,UL94V-0
  - 1.2.INSERT: THERMOPLASTIC,UL94V-0
  - 1.3.CENTER CONTACT : COPPER ALLOY,Au PLATING
- 2.NUMBER OF CONTACT : 2 TO 14 POSITION
- 3.RoHS DIRECTIVE COMPLIANCE

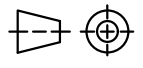
|   |                      |  |          |  |             |   |          |          |            |               |
|---|----------------------|--|----------|--|-------------|---|----------|----------|------------|---------------|
| THIRD ANGLE PROJECTION  |                      | TOLERANCES UNLESS OTHERWISE SPECIFIED                              |          | <br><b>Dongguan Ciron Technology Co.,Ltd.</b> |             |   |          |          |            |               |
| <br>UNITS    ■ mm    □ INCH<br>ANGLES   0 PLC ± 3<br>1 PLC ± 2 |                      | 0 PLC ± 1.00<br>1 PLC ± 0.50<br>2 PLC ± 0.25<br>3 PLC ±<br>4 PLC ± |          |  |             | TITLE:<br>1P CIRCULAR CONNECTOR STRAIGHT PLUGS<br>Nut=For fitting a bend relief type-IP50 |          |          |            |               |
| APPROVED BY   | JACK                 | DATE   | 2018-6-8 | C  | DRAWING NO. | A-M-005   | REV.     | B2       |            |               |
| CHECKED BY  | CHARLES              | DATE   | 2018-6-8 |  | PART NO.    | 1PXM1XXXXXXBXX  |          |          |            |               |
| REVISION  | REVISION DESCRIPTION | ECR/ECN NO.  | DATE     | DRAWN BY   | ANDY        | DATE  | 2018-6-8 | SIZE: A3 | SCALE: 1:1 | SHEET: 1 OF 2 |

|      |                      |             |          |
|------|----------------------|-------------|----------|
| B2   | Change fo P/N        | EC18010     | 2018-6-6 |
| REV. | REVISION DESCRIPTION | ECR/ECN NO. | DATE     |

KEYING (PLUG FRONT VIEW):

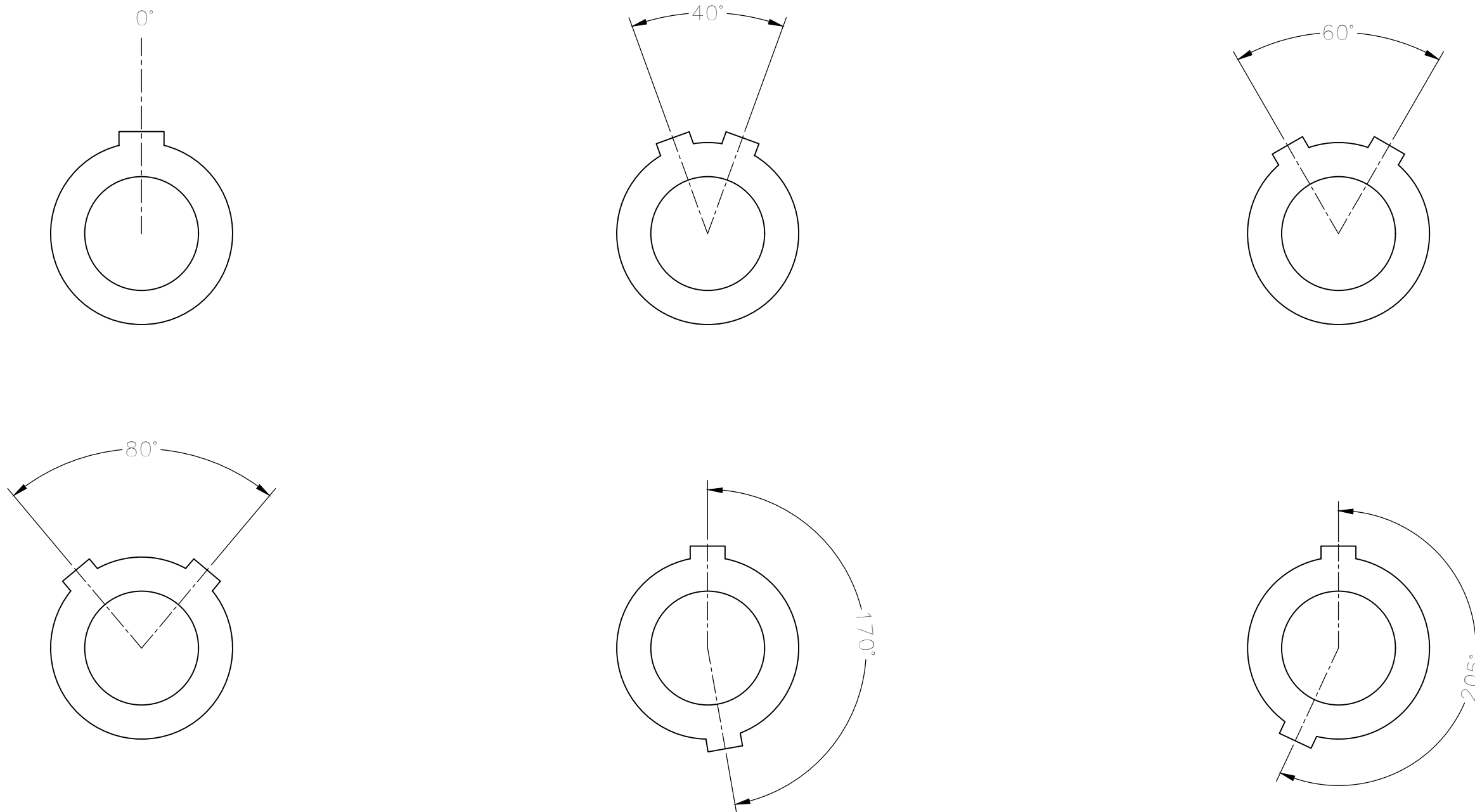

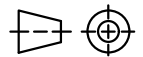
|   |  |  |         |   |          |   |
|---|--|--|---------|---|----------|---|
| THIRD ANGLE PROJECTION  |  | TOLERANCES UNLESS OTHERWISE SPECIFIED                              |         | <br><b>Dongguan Circon Technology Co.,Ltd.</b> |          |   |
| <br>UNITS <input checked="" type="checkbox"/> mm <input type="checkbox"/> INCH |  | 0 PLC ± 1.00<br>1 PLC ± 0.50<br>2 PLC ± 0.25<br>3 PLC ±<br>4 PLC ± |         |   |          | TITLE:<br>1P CIRCULAR CONNECTOR STRAIGHT PLUGS<br>Nut=For fitting a bend relief type-IP50 |
| ANGLES    0 PLC ± 3<br>1 PLC ± 2  |  | APPROVED BY  | JACK    | DATE  | 2018-6-8 | C    DRAWING NO.    A-M-005    REV.    B2   |
|   |  | CHECKED BY   | CHARLES | DATE  | 2018-6-8 |   |
|   |  | DRAWN BY   | ANDY    | DATE  | 2018-6-8 | SIZE: A3    SCALE: 1:1    SHEET: 2 OF 2   |

|      |                      |             |          |
|------|----------------------|-------------|----------|
| B2   | Change fo P/N        | EC18010     | 2018-6-6 |
| REV. | REVISION DESCRIPTION | ECR/ECN NO. | DATE     |