

8 7 6 5 4 3 2 1

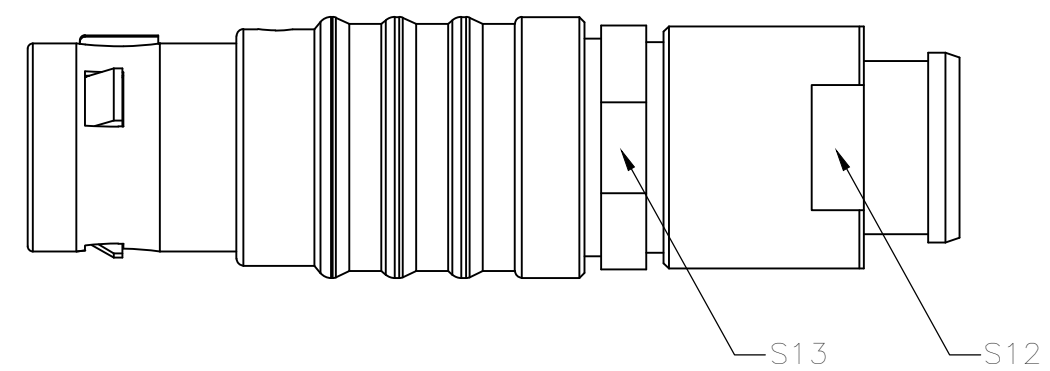
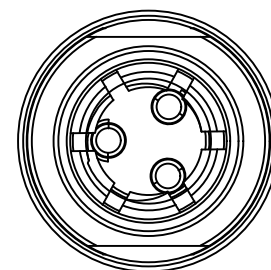
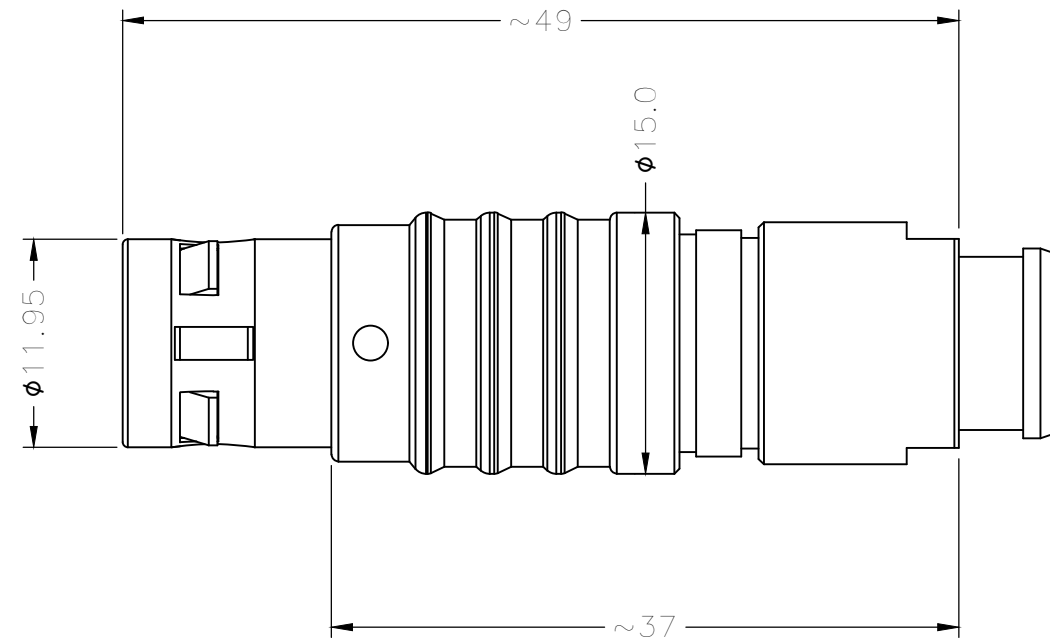
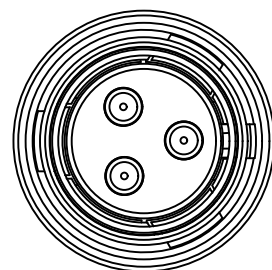

2B METAL CIRCULAR ASSEMBLY P/N DESCRIPTION :

2B A M1 X X XX X XX B
 ① ② ③ ④ ⑤

- ① Insert
P=PEEK
1=PPS
- ② Plating
2=High Gold
A=Gold flash
- ③ Number of contacts
02=2Pin
.....
32=32Pin
- ④ Keying
G= 0° E= 120°
A= 30° F= 145°
B= 45° J= 37.5°
C= 60° K= 52.5°
D= 95° L= 70°
- ⑤ Cable collet
22=2.2mm (Cable ϕ 1.4~2.2mm)
32=3.2mm (Cable ϕ 2.2~3.2mm)
42=4.2mm (Cable ϕ 3.2~4.2mm)
52=5.2mm (Cable ϕ 4.2~5.2mm)
62=6.2mm (Cable ϕ 5.2~6.2mm)
72=7.2mm (Cable ϕ 6.2~7.2mm)
82=8.2mm (Cable ϕ 7.2~8.2mm)
92=9.2mm (Cable ϕ 8.2~9.2mm)
99=9.9mm (Cable ϕ 9.2~9.9mm)

NOTE:
 1. MATERIAL:
 1.1.SHELL ASSEMBLY: COPPER ALLOY,OUTER SHELL AND COLLET NUT Cr PLATING,
 OTHER METALLIC COMPONENTS Ni PLATING
 1.2.INSERT: THERMOPLASTIC,UL94V-0
 1.3.CENTER CONTACT : COPPER ALLOY,Au PLATING
 2.NUMBER OF CONTACT : 2 TO 32 POSITION
 3.RoHS DIRECTIVE COMPLIANCE

THIRD ANGLE PROJECTION 		TOLERANCES UNLESS OTHERWISE SPECIFIED		 Dongguan Circon Technology Co.,Ltd.						
UNITS <input checked="" type="checkbox"/> mm <input type="checkbox"/> INCH		0 PLC ± 1.00 1 PLC ± 0.50 2 PLC ± 0.25 3 PLC ± 4 PLC ±					TITLE: 2B METAL CIRCULAR CONNECTOR STRAIGHT PLUGS			
ANGLES 0 PLC ± 3 1 PLC ± 2		APPROVED BY	JACK	DATE	2017-9-28	C	DRAWING NO.	A-M-016	REV.	A0
		CHECKED BY	CHARLES	DATE	2017-9-28		PART NO.	2BAM1XXXXXXB		
REV.	REVISION DESCRIPTION	ECR/ECN NO.	DATE	DRAWN BY	ANDY	DATE	2017-9-28	SIZE: A3	SCALE: 1:1	SHEET: 1 OF 3

8 7 6 5 4 3 2 1

KEYING (PLUG FRONT VIEW):

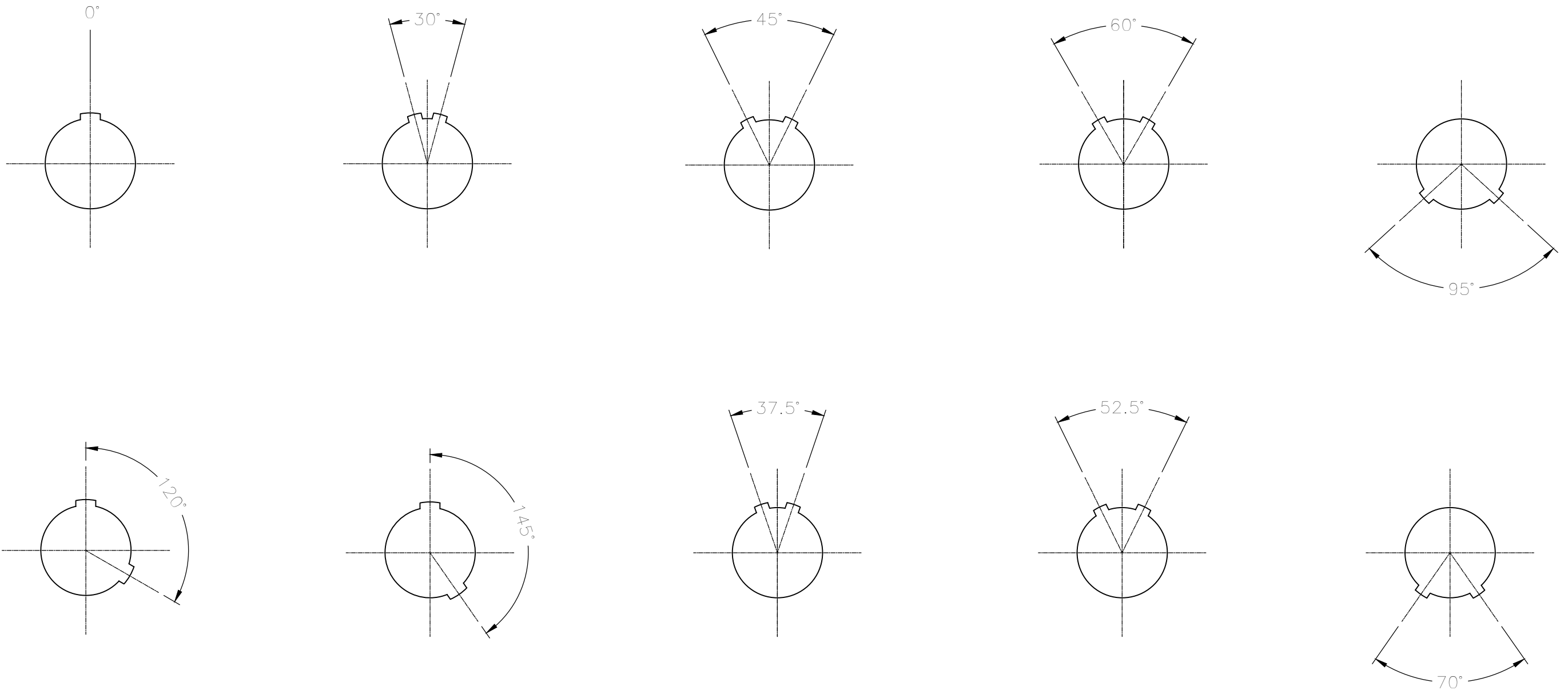

THIRD ANGLE PROJECTION	
UNITS	<input checked="" type="checkbox"/> mm <input type="checkbox"/> INCH
ANGLES	0 PLC ± 3 1 PLC ± 2

TOLERANCES UNLESS OTHERWISE SPECIFIED	
0 PLC	± 1.00
1 PLC	± 0.50
2 PLC	± 0.25
3 PLC	±
4 PLC	±

Dongguan Circon Technology Co.,Ltd.

TITLE: 2B METAL CIRCULAR CONNECTOR STRAIGHT PLUGS

APPROVED BY	JACK	DATE	2017-9-28
CHECKED BY	CHARLES	DATE	2017-9-28

C	DRAWING NO.	A-M-016	REV. A0
	PART NO.	2BAM1XXXXXXXXB	

REV.	REVISION DESCRIPTION	ECR/ECN NO.	DATE	DRAWN BY	ANDY	DATE	2017-9-28	SIZE: A3	SCALE: 1:1	SHEET: 2 OF 3
------	----------------------	-------------	------	----------	------	------	-----------	----------	------------	---------------

VIEW FROM TERMINATION SIDE PIN PART

2 POS.

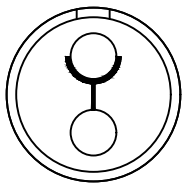

3 POS.

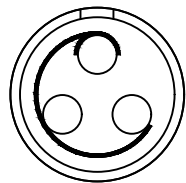

4 POS.

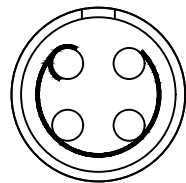

5 POS.

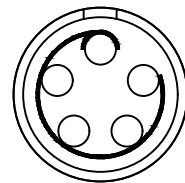

6 POS.

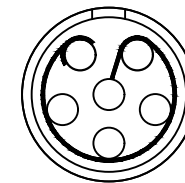

7 POS.

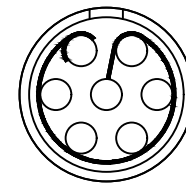

8 POS.

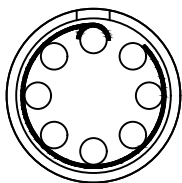

10 POS.

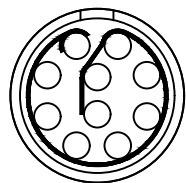

12 POS.

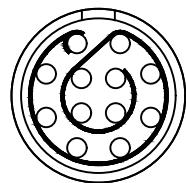

14 POS.

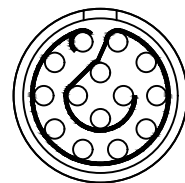

16 POS.

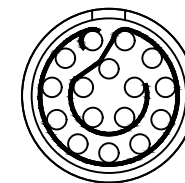

18 POS.

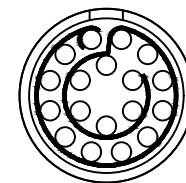

19 POS.

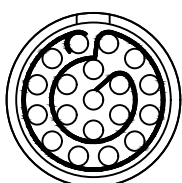

26 POS.

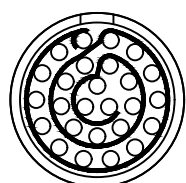

32 POS.

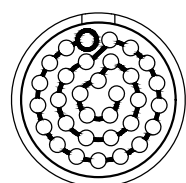

THIRD ANGLE PROJECTION 		TOLERANCES UNLESS OTHERWISE SPECIFIED		 Dongguan Circon Technology Co.,Ltd.		
UNITS <input checked="" type="checkbox"/> mm <input type="checkbox"/> INCH		0 PLC ± 1.00 1 PLC ± 0.50 2 PLC ± 0.25 3 PLC ± 4 PLC ±				
ANGLES 0 PLC ± 3 1 PLC ± 2		TITLE: 2B METAL CIRCULAR CONNECTOR STRAIGHT PLUGS		C	DRAWING NO. A-M-016 PART NO. 2BAM1XXXXXXXXB	
APPROVED BY	JACK	DATE	2017-9-28		REV.	A0
CHECKED BY	CHARLES	DATE	2017-9-28			
DRAWN BY	ANDY	DATE	2017-9-28	SIZE: A3	SCALE: 1:1	SHEET: 3 OF 3

REV.	REVISION DESCRIPTION	ECR/ECN NO.	DATE