

PANEL CUT-OUT

2B METAL CIRCULAR ASSEMBLY P/N DESCRIPTION :

2B A F1 X X XX X 00C
 ① ② ③ ④

- ① Insert
 P=PEEK
 1=PPS
- ② Plating
 2=High Gold
 A=Gold flash
- ③ Number of contacts
 02=2Pin
 ...
 32=32Pin
- ④ Keying
 G=0° E=120°
 A=30° F=145°
 B=45° J=37.5°
 C=60° K=52.5°
 D=95° L=70°

NOTE:
 1. MATERIAL:
 1.1.SHELL ASSEMBLY: COPPER ALLOY,OUTER SHELL AND COLLET NUT Cr PLATING,
 OTHER METALLIC COMPONENTS Ni PLATING
 1.2.INSERT: THERMOPLASTIC,UL94V-0
 1.3.CENTER CONTACT : COPPER ALLOY,Au PLATING
 2.NUMBER OF CONTACT : 2 TO 32 POSITION
 3.RoHS DIRECTIVE COMPLIANCE

THIRD ANGLE PROJECTION 		TOLERANCES UNLESS OTHERWISE SPECIFIED		 Dongguan Circon Technology Co.,Ltd.						
UNITS ■ mm □ INCH		0 PLC ± 1.00 1 PLC ± 0.50 2 PLC ± 0.25 3 PLC ± 4 PLC ±					TITLE: 2B METAL CIRCULAR CONNECTOR FIXED SOCKET			
APPROVED BY	JACK	DATE	2018-12-8	C	DRAWING NO.	A-M-066	REV.	A0		
CHECKED BY	CHARLES	DATE	2018-12-8		PART NO.	2BAF1XXXXX00C				
REV.	REVISION DESCRIPTION	ECR/ECN NO.	DATE	DRAWN BY	ANDY	DATE	2018-12-8	SIZE: A3	SCALE: 1:1	SHEET: 1 OF 3

KEYING ANGLES (RECEPTACLE FRONT VIEW):

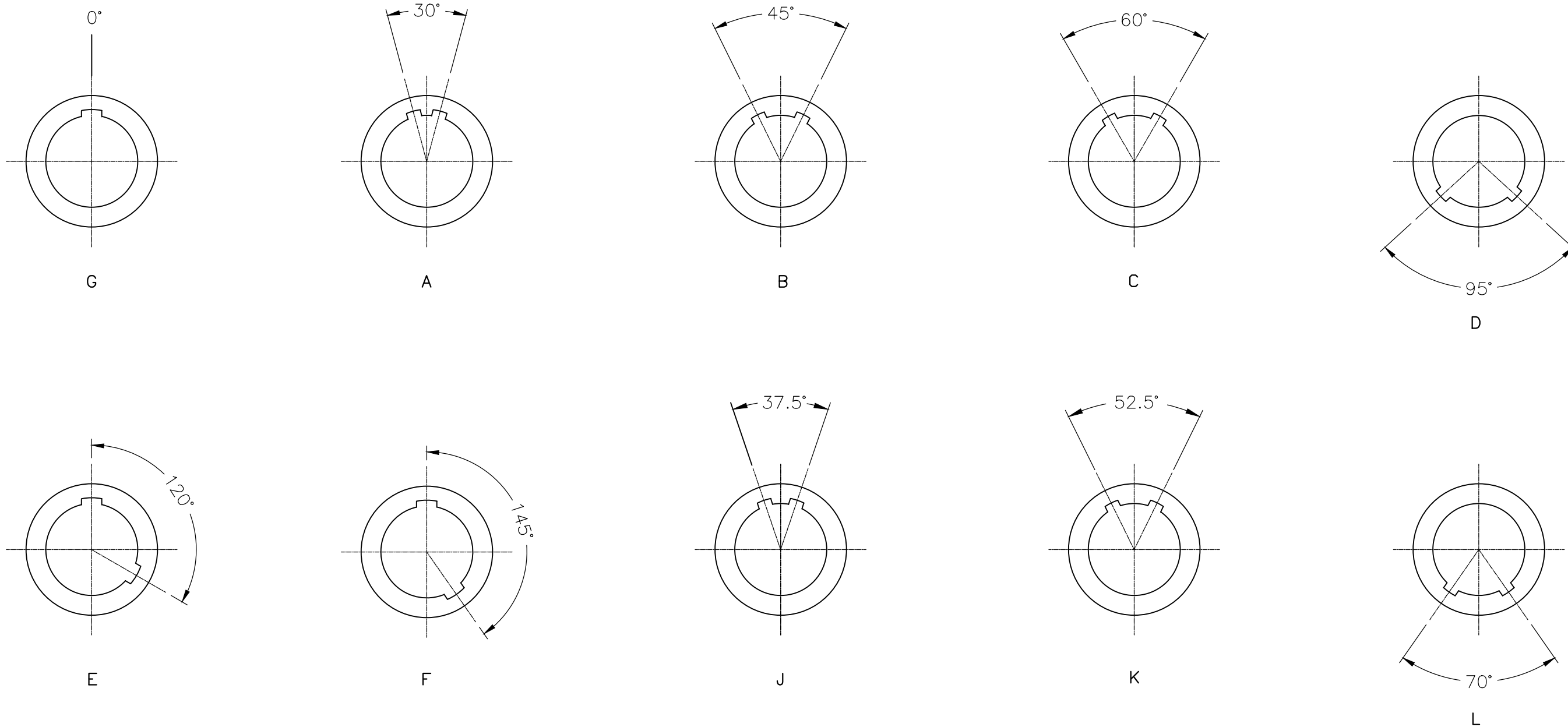

THIRD ANGLE PROJECTION 		TOLERANCES UNLESS OTHERWISE SPECIFIED		 Dongguan Circon Technology Co.,Ltd.				
UNITS <input checked="" type="checkbox"/> mm <input type="checkbox"/> INCH		0 PLC ± 1.00 1 PLC ± 0.50 2 PLC ± 0.25 3 PLC ± 4 PLC ±						
ANGLES 0 PLC ± 3 1 PLC ± 2		APPROVED BY JACK CHECKED BY CHARLES DATE 2018-12-8 DATE 2018-12-8		TITLE: 2B METAL CIRCULAR CONNECTOR FIXED SOCKET DRAWING NO. A-M-066 PART NO. 2BAF1XXXXX00C REV. A0				
REV.	REVISION DESCRIPTION	ECR/ECN NO.	DATE	DRAWN BY ANDY	DATE 2018-12-8	SIZE: A3	SCALE: 1:1	SHEET: 2 OF 3

VIEW FROM TERMINATION SIDE PIN PART

2 POS.

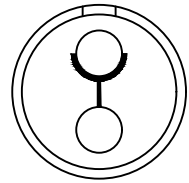

3 POS.

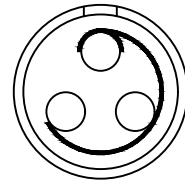

4 POS.

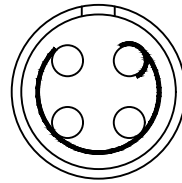

5 POS.

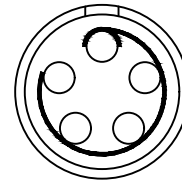

6 POS.

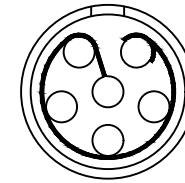

7 POS.

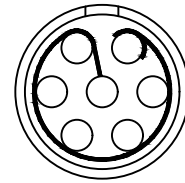

8 POS.

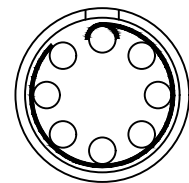

10 POS.

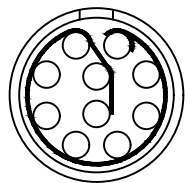

12 POS.

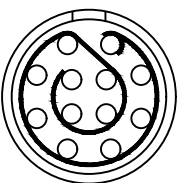

14 POS.

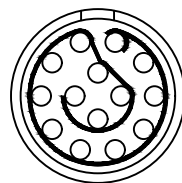

16 POS.

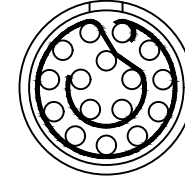

18 POS.

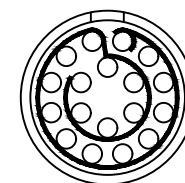

19 POS.

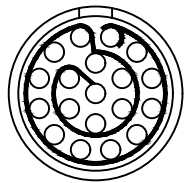

26 POS.

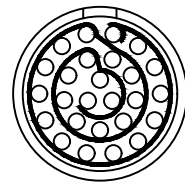

32 POS.

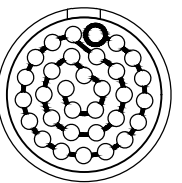

THIRD ANGLE PROJECTION

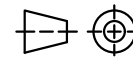

TOLERANCES UNLESS OTHERWISE SPECIFIED

UNITS mm INCH

ANGLES 0 PLC ± 3
1 PLC ± 2

0 PLC ± 1.00
1 PLC ± 0.50
2 PLC ± 0.25
3 PLC ±
4 PLC ±



Dongguan Circon Technology Co.,Ltd.

TITLE: 2B METAL CIRCULAR CONNECTOR
FIXED SOCKET

APPROVED BY JACK DATE 2018-12-8

CHECKED BY CHARLES DATE 2018-12-8

DRAWN BY ANDY DATE 2018-12-8

DRAWING NO. A-M-066 REV. A0

PART NO. 2BAF1XXXXX00C

SIZE: A3 SCALE: 1:1 SHEET: 3 OF 3

REV.	REVISION DESCRIPTION	ECR/ECN NO.	DATE